

# rail

## technical info

**scrivania in legno** · wooden desk · bureau en bois  
Schreibtisch aus Holz · bureau in hout · escritorio de madera

**scrivania in vetro** · glass desk · bureau en verre  
Schreibtisch aus Glas · bureau in glas · escritorio de cristal

**L x P x H**

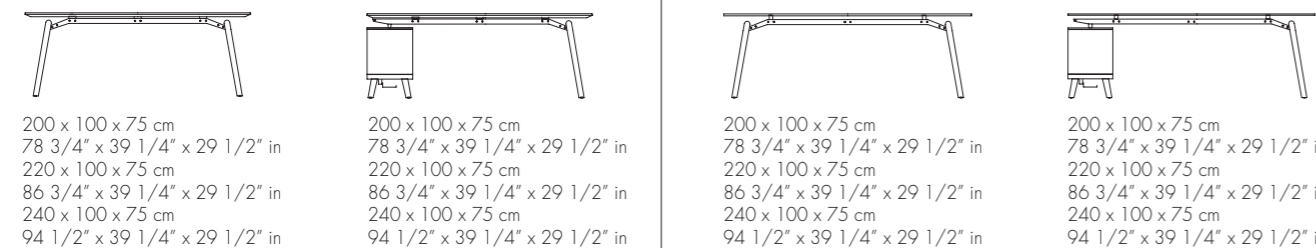

**scrivania in legno** · wooden desk · bureau en bois  
Schreibtisch aus Holz · bureau in hout · escritorio de madera

**scrivania in vetro** · glass desk · bureau en verre  
Schreibtisch aus Glas · bureau in glas · escritorio de cristal

**L x P x H**

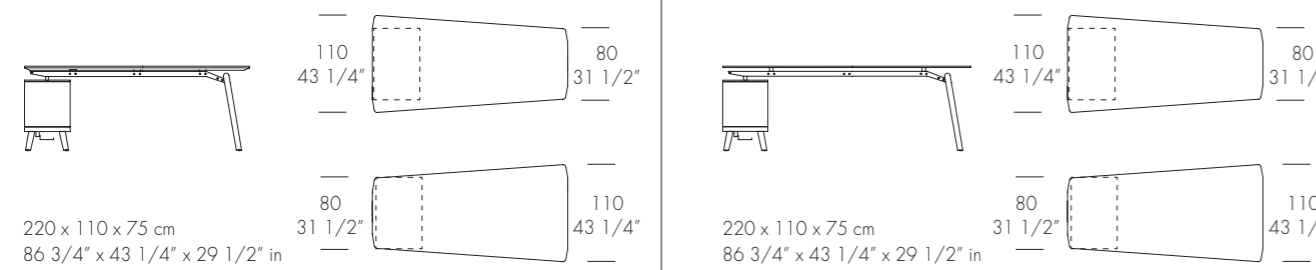

**pannello modesty** · modesty panel · voile de fond · Modesty Paneel · knieschot · panel de protección

**L x P x H**

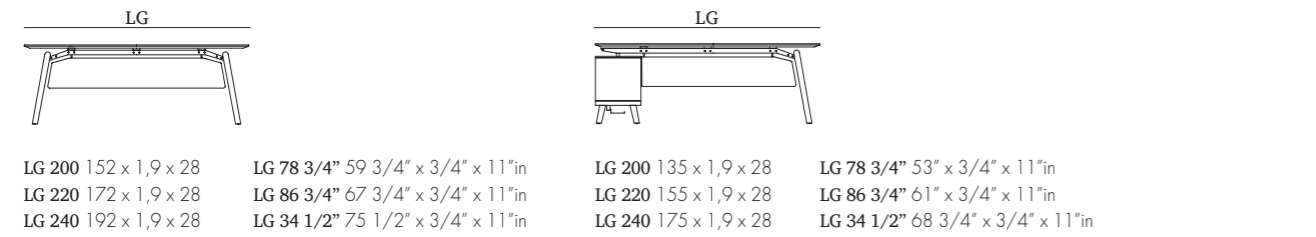

**posizione passacavi** · cable guide position · position passe-câbles · Kabeldurchlass Position · positie kabeldoorvoer · posición pasacables    Ø 80 - Ø 3"

**scrivania in legno** · wooden desk · bureau en bois  
Schreibtisch aus Holz · bureau in hout · escritorio de madera

**scrivania in vetro** · glass desk · bureau en verre  
Schreibtisch aus Glas · bureau in glas · escritorio de cristal

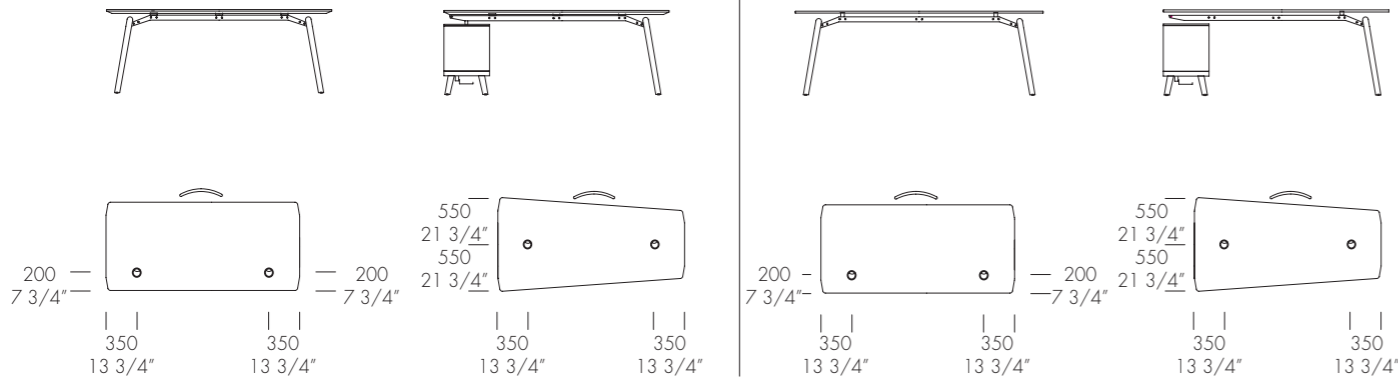

\* con passacavi · with cable guide · avec passe-câbles · mit Kabeldurchlass · met kabeldoorvoer · con pasacables

**tavolo riunione in legno** · wooden conference table · table de réunion en bois  
Konferenztisch aus Holz · vergadertafel in hout · mesa de reuniones de madera

**tavolo riunione in vetro** · glass conference table · table de réunion en verre  
Konferenztisch aus Glas · vergadertafel in glazen · mesa de reuniones de cristal

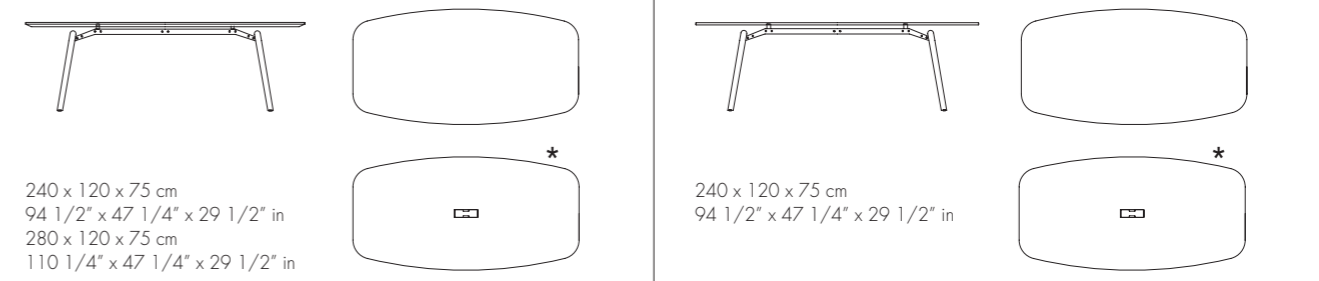
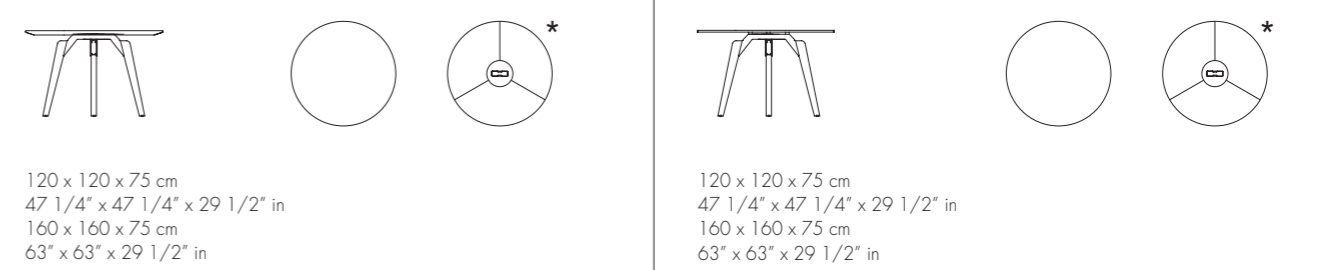
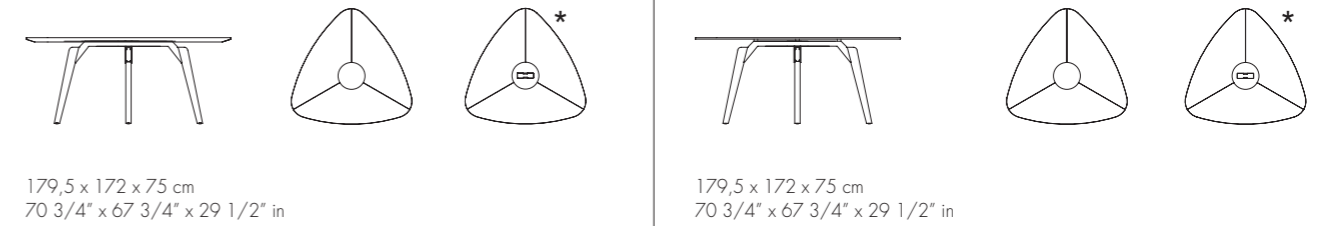

**tavolo riunione in legno** · wooden conference table · table de réunion en bois · Konferenztisch aus Holz · vergadertafel in hout · mesa de reuniones de madera

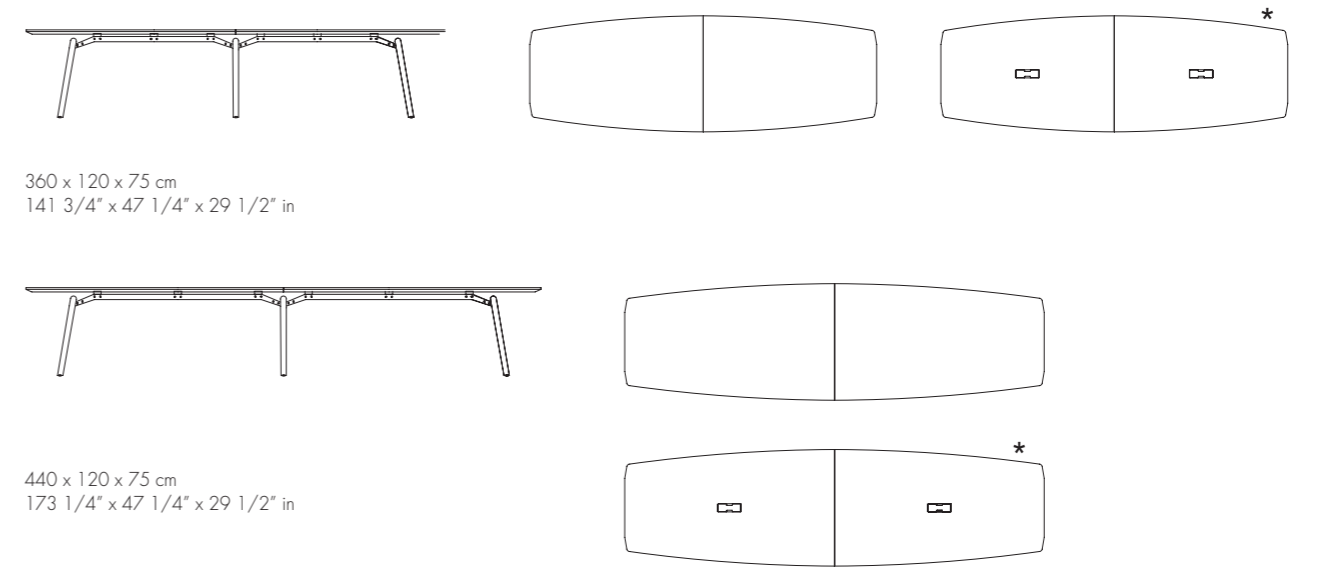

# rail

## technical info

mobili di servizio · service cabinets · dessertes · Werkbox/Module · meubels · muebles de servicio

L x P x H

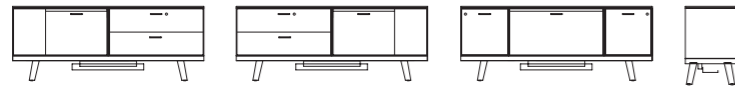

160 x 40 x 62 cm  
63" x 15 3/4" x 24 1/2" in

160 x 40 x 62 cm  
63" x 15 3/4" x 24 1/2" in

160 x 40 x 62 cm  
63" x 15 3/4" x 24 1/2" in

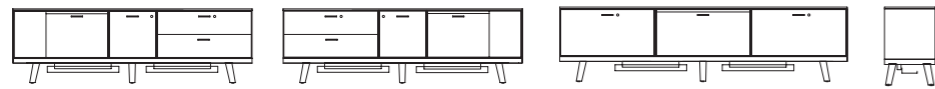

200 x 40 x 62 cm  
78 3/4" x 15 3/4" x 24 1/2" in

200 x 40 x 62 cm  
78 3/4" x 15 3/4" x 24 1/2" in

240 x 40 x 62 cm  
94 1/2" x 15 3/4" x 24 1/2" in

credenze · cabinets · armoires basses · Schränke · kasten · aparadores

L x P x H

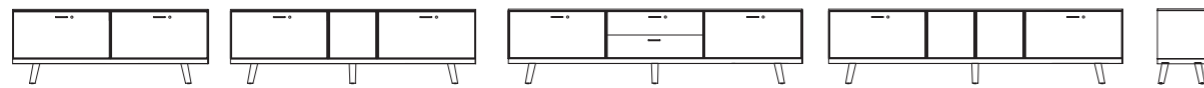

160 x 40 x 62 cm  
63" x 15 3/4" x 24 1/2" in

200 x 40 x 62 cm  
78 3/4" x 15 3/4" x 24 1/2" in

240 x 40 x 62 cm  
94 1/2" x 15 3/4" x 24 1/2" in

240 x 40 x 62 cm  
94 1/2" x 15 3/4" x 24 1/2" in

mobili di servizio · service cabinets · dessertes · Werkbox/Module · meubels · muebles de servicio

L x P x H

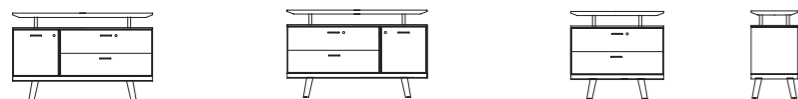

**legno** · wood  
bois · Holz  
hout · madera

120 x 40 x 75 cm  
47 1/4" x 15 3/4" x 29 1/2" in

**legno** · wood  
bois · Holz  
hout · madera

120 x 40 x 75 cm  
47 1/4" x 15 3/4" x 29 1/2" in

**legno** · wood  
bois · Holz  
hout · madera

80 x 40 x 75 cm  
31 1/2" x 15 3/4" x 29 1/2" in

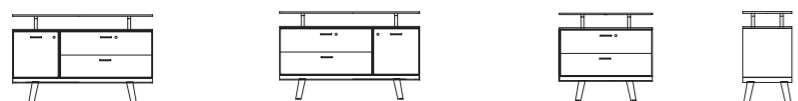

**vetro** · glass  
verre · Glas  
glas · cristal

120 x 40 x 75 cm  
47 1/4" x 15 3/4" x 29 1/2" in

**vetro** · glass  
verre · Glas  
glas · cristal

120 x 40 x 75 cm  
47 1/4" x 15 3/4" x 29 1/2" in

**vetro** · glass  
verre · Glas  
glas · cristal

80 x 40 x 75 cm  
31 1/2" x 15 3/4" x 29 1/2" in

credenze · cabinets · armoires basses · Schränke · kasten · aparadores

L x P x H

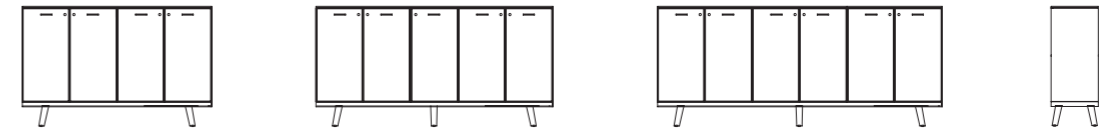

160 x 40 x 102 cm  
63" x 15 3/4" x 40" in

200 x 40 x 102 cm  
78 3/4" x 15 3/4" x 40" in

240 x 40 x 102 cm  
94 1/2" x 15 3/4" x 40" in

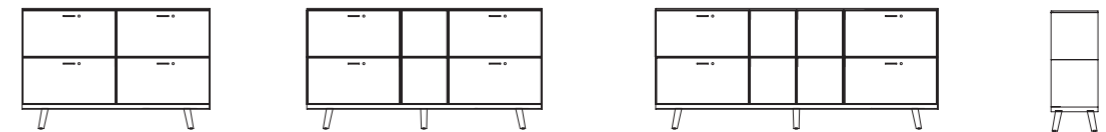

160 x 40 x 102 cm  
63" x 15 3/4" x 40" in

200 x 40 x 102 cm  
78 3/4" x 15 3/4" x 40" in

240 x 40 x 102 cm  
94 1/2" x 15 3/4" x 40" in

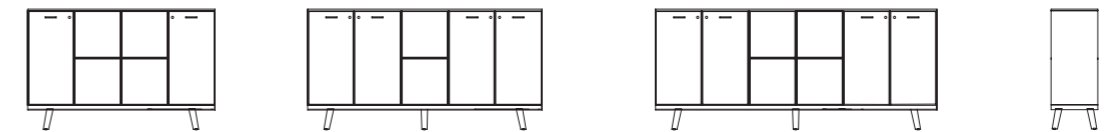

160 x 40 x 102 cm  
63" x 15 3/4" x 40" in

200 x 40 x 102 cm  
78 3/4" x 15 3/4" x 40" in

240 x 40 x 102 cm  
94 1/2" x 15 3/4" x 40" in

# rail

## finishes

### legni

woods · bois · holz · hout · maderá

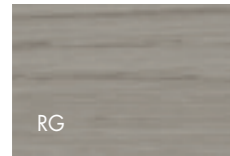

rovere grigio  
grey oak  
chêne gris  
Eiche grau  
grijs eiken  
roble gris



rovere laccato nero  
black lacquered oak  
chêne laqué noir  
schwarz lackierter Eiche  
zwart gelakt eiken  
roble lacado negro

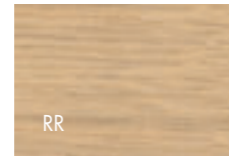

rovere naturale  
natural oak  
chêne naturel  
Natur Eiche  
eikenhout natuur  
roble natural

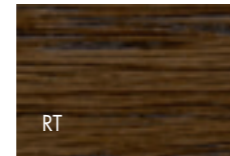

rovere tabacco  
tobacco oak  
chêne tabac  
Eiche Tabak  
eikenhout tabak  
roble tabaco

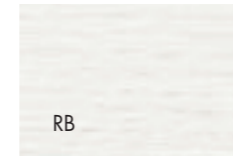

rovere laccato bianco  
white lacquered oak  
chêne laqué blanc  
weiß lackierter Eiche  
wit gelakt eiken  
roble lacado blanco

### laccati

lacquered · laqués · Lackiertes · gelakt · laqueado

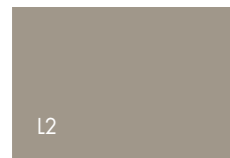

tortora  
turtledove  
tourterelle  
taubengrau  
tortelduif  
törtola

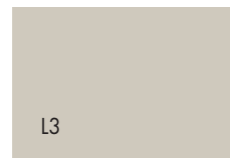

nebbia  
mist  
brouillard  
nebelgrau  
mist  
niebla

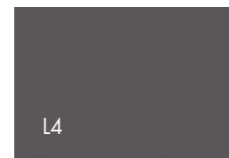

titanio  
titanium  
litane  
Titan  
titanium  
titanio

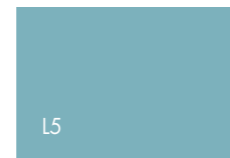

oceano  
ocean  
océan  
Meerblau  
ocean  
océano

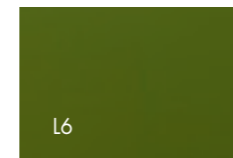

verde muschio  
moss green  
vert mousse  
moosgrün  
mosgroen  
verde musgo

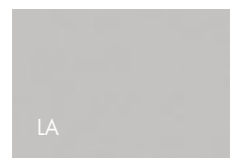

alluminio  
aluminium  
aluminium  
Aluminium  
aluminium  
aluminio

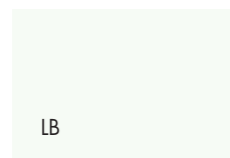

bianco  
white  
blanc  
Weiß  
wit  
blanco

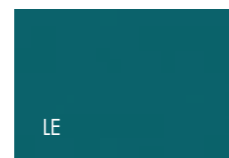

deep teal  
deep teal  
bleu canard  
Deep Teal  
deep teal  
deep teal

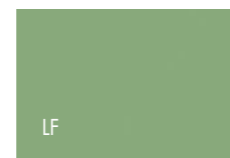

verde natura  
gras green  
vert nature  
grasgrün  
groene natuur  
verde naturaleza



nero  
black  
noir  
Schwarz  
zwart  
negro

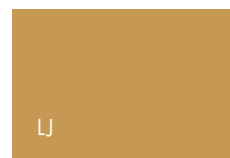

giallo gold  
yellow gold  
jaune or  
goldgelb  
geelgouden  
loro amarillo



bordeaux  
bordeaux  
bordeaux  
bordeaux  
bordeaux  
burdeos

### melaminici

melamine · mélamine · Melamin · melamine · melamina



bianco  
white  
blanc  
weiß  
wit  
blanco

### parti metalliche

metal parts · pièces métalliques · metallteile · metalen onderdelen · piezas de metal



cromo lucido  
glossy chrome  
chromé brillant  
Chrom poliert  
glanzend verchroomd  
cromo pulido

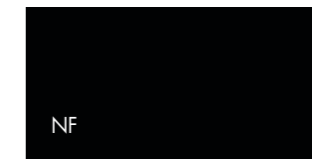

nero  
black  
noir  
Schwarz  
zwart  
negro

### vetro temperato

tempered glass · verre trempé · gehärtetes Glas · gehard glas · vidrio templado



trasparente  
transparent  
transparent  
Transparentes  
transparente  
transparente

### vetroceramica

glass ceramic · vitroceramique · glaskeramik · vitrokeramisch · vitroceramica



Bianco Calacatta lucido  
Glossy white Calacatta  
Blanc brillant Calacatta  
Weiß glänzend Calacatta  
Glanzend wit Calacatta  
Calacatta blanco brillo

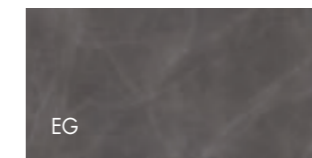

Grigio Stone opaco  
Stone grey matt  
Gris mat Stone  
Grau matt Stone  
Grijs Stone mat  
Gris mate Stone



Nero Marquinia opaco  
Marquinia black matt  
Noir mat Marquinia  
Schwarz matt Marquinia  
Zwart Marquinia mat  
Marquinia negro mate

### pelle ecologica

eco leather · cuir écologique · ecopell-leder · Kunstleder · piel ecológica

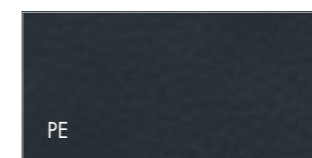

nero  
black  
noir  
Schwarz  
zwart  
negro

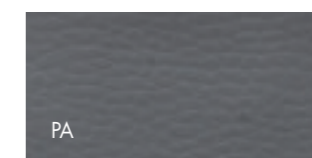

titanio  
titanium coloured  
titane  
Titan  
titanium  
titanio

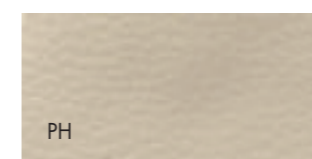

Nebbia  
dark white colour  
brouillard  
Nebel  
Grijswit  
gris claro